

SL Paper 1

A mass at the end of a string is swung in a horizontal circle at increasing speed until the string breaks.

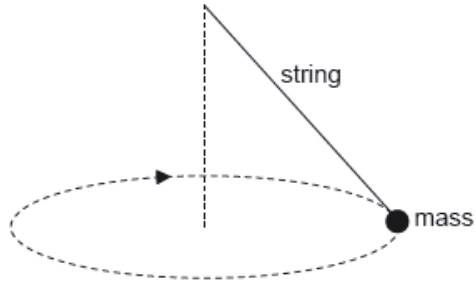

The subsequent path taken by the mass is a

- A. line along a radius of the circle.
- B. horizontal circle.
- C. curve in a horizontal plane.
- D. curve in a vertical plane.

An object rotates in a horizontal circle when acted on by a centripetal force F . What is the centripetal force acting on the object when the radius of the circle doubles and the kinetic energy of the object halves?

- A. $\frac{F}{4}$
- B. $\frac{F}{2}$
- C. F
- D. $4F$

An object at the end of a wooden rod rotates in a vertical circle at a constant angular velocity. What is correct about the tension in the rod?

- A. It is greatest when the object is at the bottom of the circle.
- B. It is greatest when the object is halfway up the circle.
- C. It is greatest when the object is at the top of the circle.
- D. It is unchanged throughout the motion.

A mass is suspended by a string from a fixed point. The mass moves with constant speed along a circular path in a horizontal plane.

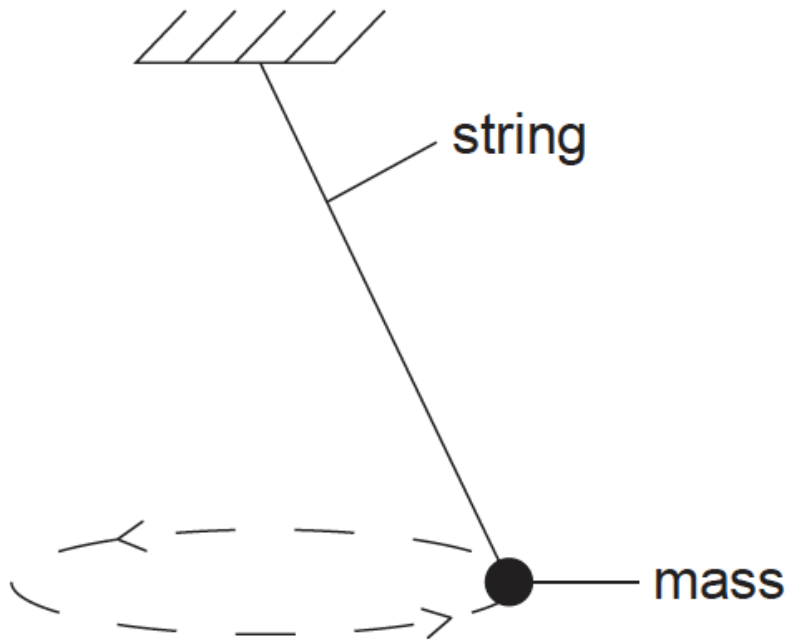

The resultant force acting on the mass is

- A. zero.
 - B. directed upwards along the string.
 - C. directed towards the centre of the circular path.
 - D. in the same direction as the velocity of the mass.
-

What is the acceleration of an object rotating with constant speed v in a circle of radius r ?

- A. Zero
 - B. $\frac{v^2}{r}$ towards the centre of the circle
 - C. $\frac{v^2}{r}$ away from the centre of the circle
 - D. $\frac{v^2}{r}$ along a tangent to the circle
-

A spherical planet of uniform density has three times the mass of the Earth and twice the average radius. The magnitude of the gravitational field strength at the surface of the Earth is g . What is the gravitational field strength at the surface of the planet?

- A. $6g$
 - B. $\frac{2}{3}g$
 - C. $\frac{3}{4}g$
 - D. $\frac{3}{2}g$
-

The maximum speed with which a car can take a circular turn of radius R is v . The maximum speed with which the same car, under the same conditions, can take a circular turn of radius $2R$ is

- A. $2v$.
 - B. $v\sqrt{2}$.
 - C. $4v$.
 - D. $2v\sqrt{2}$.
-

Which single condition enables Newton's universal law of gravitation to be used to predict the force between the Earth and the Sun?

- A. The Earth and the Sun both have a very large radius.
 - B. The distance between the Earth and the Sun is approximately constant.
 - C. The Earth and the Sun both have a very large mass.
 - D. The Earth and the Sun behave as point masses.
-

On Mars, the gravitational field strength is about $\frac{1}{4}$ of that on Earth. The mass of Earth is approximately ten times that of Mars.

What is $\frac{\text{radius of Earth}}{\text{radius of Mars}}$?

- A. 0.4
 - B. 0.6
 - C. 1.6
 - D. 2.5
-

A car moves at constant speed around a horizontal circular track. The resultant force on the car is always equal to

- A. the forward force from the engine.
 - B. the sideways friction between the tires and the track.
 - C. the weight of the car.
 - D. zero.
-

The weight of an object of mass 1 kg at the surface of Mars is about 4 N. The radius of Mars is about half the radius of Earth. Which of the following is the best estimate of the ratio below?

$$\frac{\text{mass of Mars}}{\text{mass of Earth}}$$

- A. 0.1

- B. 0.2
 - C. 5
 - D. 10
-

The centres of two planets are separated by a distance R . The gravitational force between the two planets is F . What will be the force between the planets when their separation increases to $3R$?

- A. $\frac{F}{9}$
 - B. $\frac{F}{3}$
 - C. F
 - D. $3F$
-

A mass at point X gives rise to a gravitational field strength g at point P as shown below.



An identical mass is placed at point Y as shown below.



The resultant gravitational field strength at P is now

- A. greater than $2g$.
 - B. between $2g$ and g .
 - C. between g and zero.
 - D. zero.
-

A small sphere X of mass M is placed a distance d from a point mass. The gravitational force on sphere X is 90 N. Sphere X is removed and a second sphere Y of mass $4M$ is placed a distance $3d$ from the same point mass. The gravitational force on sphere Y is

- A. 480 N.
 - B. 160 N.
 - C. 120 N.
 - D. 40 N.
-

The gravitational field strength at the surface of Earth is g . Another planet has double the radius of Earth and the same density as Earth. What is the gravitational field strength at the surface of this planet?

- A. $\frac{g}{2}$
 - B. $\frac{g}{4}$
 - C. $2g$
 - D. $4g$
-

Newton's law of gravitation

- A. is equivalent to Newton's second law of motion.
 - B. explains the origin of gravitation.
 - C. is used to make predictions.
 - D. is not valid in a vacuum.
-

For a particle moving at constant speed in a horizontal circle, the work done by the centripetal force is

- A. zero.
 - B. directly proportional to the particle mass.
 - C. directly proportional to the particle speed.
 - D. directly proportional to the (particle speed)².
-

An object of mass m at the end of a string of length r moves in a vertical circle at a constant angular speed ω .

What is the tension in the string when the object is at the bottom of the circle?

- A. $m(\omega^2 r + g)$
 - B. $m(\omega^2 r - g)$
 - C. $mg(\omega^2 r + 1)$
 - D. $mg(\omega^2 r - 1)$
-

A spacecraft travels away from Earth in a straight line with its motors shut down. At one instant the speed of the spacecraft is 5.4 km s^{-1} . After a time of 600 s, the speed is 5.1 km s^{-1} . The average gravitational field strength acting on the spacecraft during this time interval is

- A. $5.0 \times 10^{-4} \text{ N kg}^{-1}$
- B. $3.0 \times 10^{-2} \text{ N kg}^{-1}$

C. $5.0 \times 10^{-1} \text{ N kg}^{-1}$

D. 30 N kg^{-1}

What is the definition of gravitational field strength at a point?

- A. Force acting per unit mass on a small mass placed at the point.
 - B. Work done per unit mass on any mass moved to the point.
 - C. Force acting on a small mass placed at the point.
 - D. Work done on any mass moved to the point.
-

A body moves with uniform speed around a circle of radius r . The period of the motion is T . What is the speed of the body?

A. $\frac{2\pi r}{T}$

B. $\frac{2\pi T}{r}$

C. Zero

D. $\frac{\pi r^2}{T}$

Planet X has mass M and radius R . Planet Y has mass $2M$ and radius $3R$. The gravitational field strength at the surface of planet X is g . What is the gravitational field strength at the surface of planet Y?

A. $\frac{2}{9}g$

B. $\frac{2}{3}g$

C. $\frac{3}{2}g$

D. $\frac{9}{2}g$

A ball is tied to a string and rotated at a uniform speed in a vertical plane. The diagram shows the ball at its lowest position. Which arrow shows the direction of the net force acting on the ball?

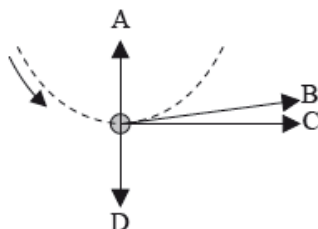

A planet has half the mass and half the radius of the Earth. What is the gravitational field strength at the surface of the planet? The gravitational field strength at the surface of the Earth is 10 N kg^{-1} .

- A. 2.5 N kg^{-1}
- B. 5.0 N kg^{-1}
- C. 10 N kg^{-1}
- D. 20 N kg^{-1}

A satellite X of mass m orbits the Earth with a period T . What will be the orbital period of satellite Y of mass $2m$ occupying the same orbit as X?

- A. $\frac{T}{2}$
- B. T
- C. $\sqrt{2T}$
- D. $2T$

An object of constant mass is tied to the end of a rope of length l and made to move in a horizontal circle. The speed of the object is increased until the rope breaks at speed v . The length of the rope is then changed. At what other combination of rope length and speed will the rope break?

	Rope length	Speed
A.	$4l$	$2v$
B.	$2l$	v
C.	$2l$	$\frac{v}{2}$
D.	$4l$	$\frac{v}{2}$

A particle P is moving anti-clockwise with constant speed in a horizontal circle.

Which diagram correctly shows the direction of the velocity v and acceleration a of the particle P in the position shown?

A.

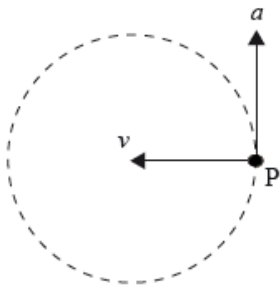

B.

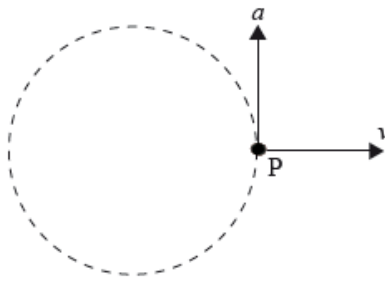

C.

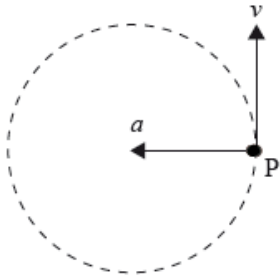

D.

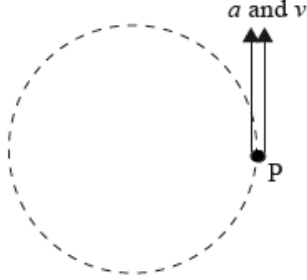

The magnitude of the gravitational field strength at the surface of a planet of mass M and radius R is g . What is the magnitude of the gravitational field strength at the surface of a planet of mass $2M$ and radius $2R$?

- A. $\frac{g}{4}$
- B. $\frac{g}{2}$
- C. g
- D. $2g$

What is the correct definition of gravitational field strength?

- A. The mass per unit weight
- B. The weight of a small test mass
- C. The force acting on a small test mass
- D. The force per unit mass acting on a small test mass

A horizontal disc rotates uniformly at a constant angular velocity about a central axis normal to the plane of the disc.

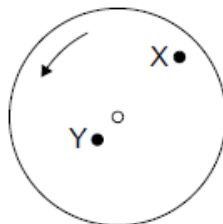

Point X is a distance $2L$ from the centre of the disc. Point Y is a distance L from the centre of the disc. Point Y has a linear speed v and a centripetal acceleration a .

What is the linear speed and centripetal acceleration of point X?

	Linear speed of X	Centripetal acceleration of X
A.	v	a
B.	$2v$	$2a$
C.	v	$2a$
D.	$2v$	$4a$

The mass of Earth is M_E , its radius is R_E and the magnitude of the gravitational field strength at the surface of Earth is g . The universal gravitational constant is G . The ratio $\frac{g}{G}$ is equal to

- A. $\frac{M_E}{R_E^2}$
- B. $\frac{R_E^2}{M_E}$
- C. $M_E R_E$
- D. 1

A communications satellite is moving at a constant speed in a circular orbit around Earth. At any given instant in time, the resultant force on the satellite is

- A. zero.
- B. equal to the gravitational force on the satellite.
- C. equal to the vector sum of the gravitational force on the satellite and the centripetal force.
- D. equal to the force exerted by the satellite's rockets.

The mass of a planet is twice that of Earth. Its radius is half that of the radius of Earth. The gravitational field strength at the surface of Earth is g . The gravitational field strength at the surface of the planet is

- A. $\frac{1}{2}g$.
- B. g .
- C. $2g$.
- D. $8g$.

An aircraft is flying at constant speed in a horizontal circle. Which of the following diagrams best illustrates the forces acting on the aircraft in the vertical plane?

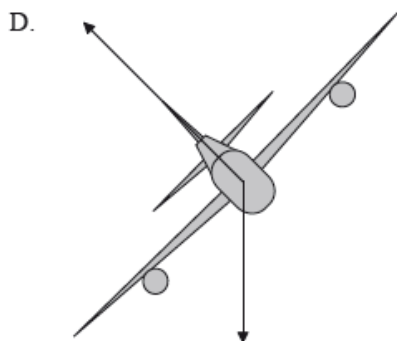
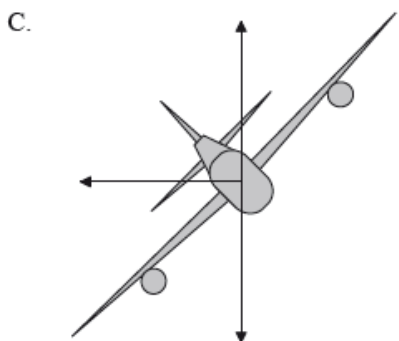
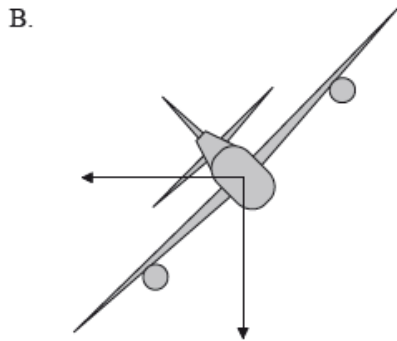
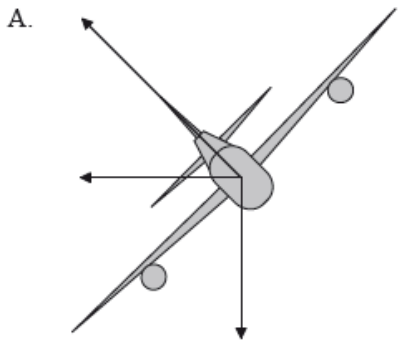

A pendulum bob is attached to a light string and is swinging in a vertical plane.

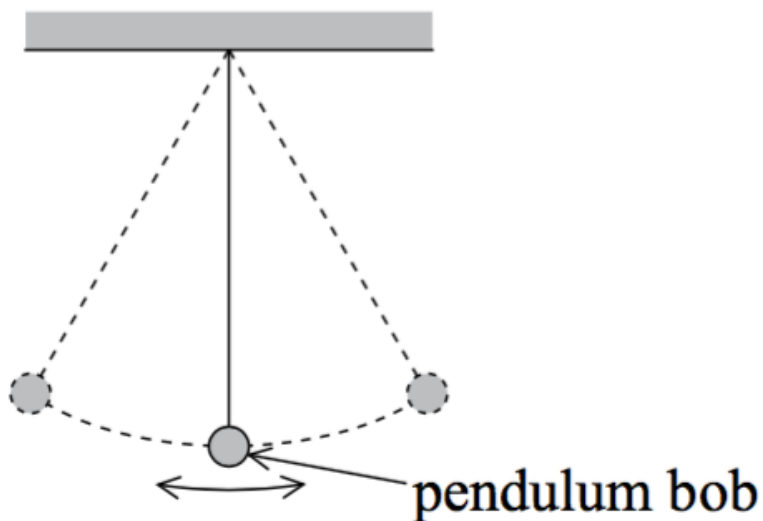

At the lowest point of the motion, the magnitude of the tension in the string is

- A. less than the weight of the mass of the pendulum bob.
- B. zero.
- C. greater than the weight of the mass of the pendulum bob.
- D. equal to the weight of the mass of the pendulum bob.

A car on a road follows a horizontal circular path at constant speed. Which of the following correctly identifies the origin and the direction of the net force on the car?

	Origin	Direction
A.	car engine	toward centre of circle
B.	car engine	away from centre of circle
C.	friction between car tyres and road	away from centre of circle
D.	friction between car tyres and road	toward centre of circle

Two pulses are travelling towards each other.

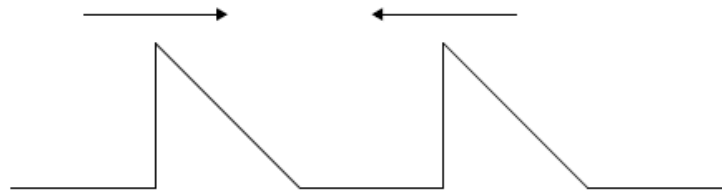

What is a possible pulse shape when the pulses overlap?

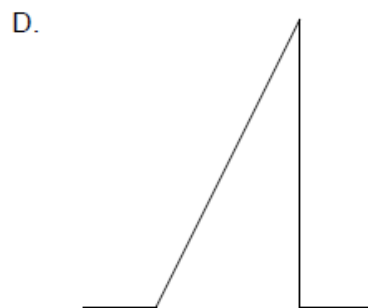
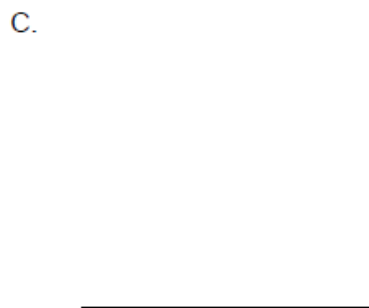
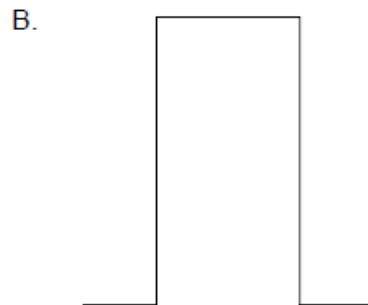
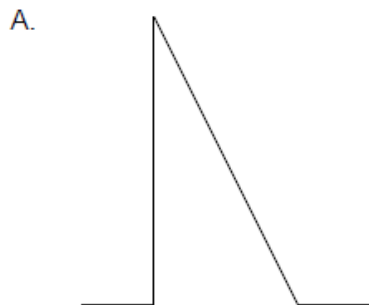

Two satellites of mass m and $2m$ orbit a planet at the same orbit radius. If F is the force exerted on the satellite of mass m by the planet and a is the centripetal acceleration of this satellite, what is the force and acceleration of the satellite with mass $2m$?

	Force	Acceleration
A.	$2F$	a
B.	$2F$	$\frac{a}{2}$
C.	F	a
D.	F	$\frac{a}{2}$

A mass attached to a string rotates in a gravitational field with a constant period in a vertical plane.

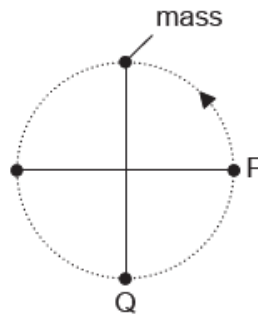

How do the tension in the string and the kinetic energy of the mass compare at P and Q?

	Tension in the string	Kinetic energy of mass
A.	greater at P than Q	greater at Q than P
B.	greater at Q than P	greater at Q than P
C.	greater at P than Q	same at Q and P
D.	greater at Q than P	same at Q and P

A cyclist rides around a circular track at a uniform speed. Which of the following correctly gives the net horizontal force on the cyclist at any given instant of time?

	Net horizontal force along direction of motion	Net horizontal force normal to direction of motion
A.	zero	zero
B.	zero	non zero
C.	non zero	zero
D.	non zero	non zero

The force F between particles in gravitational and electric fields is related to the separation r of the particles by an equation of the form

$$F = a \frac{bc}{r^2}.$$

Which of the following identifies the units for the quantities a , b and c for a gravitational field?

	a	b and c
A.	Nm^2C^{-2}	C
B.	Nm^2C^{-2}	kg
C.	$\text{Nm}^2\text{kg}^{-2}$	C
D.	$\text{Nm}^2\text{kg}^{-2}$	kg

An electron moves with uniform circular motion in a region of magnetic field. Which diagram shows the acceleration a and velocity v of the electron at point P?

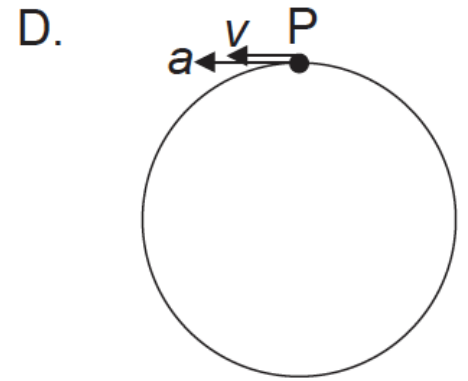
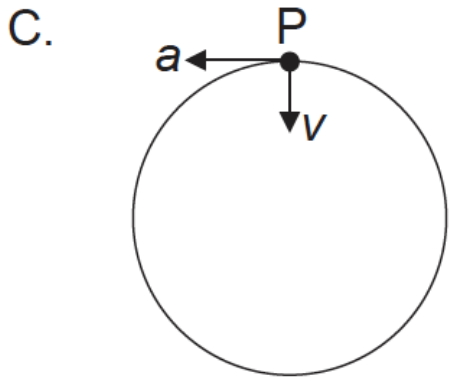
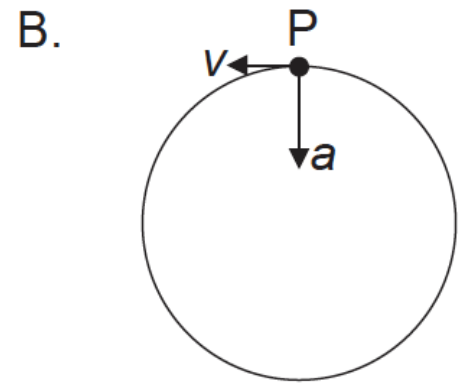
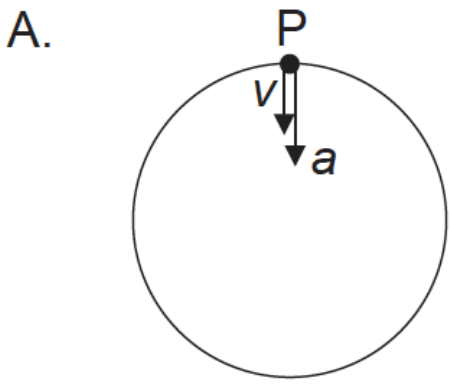

A mass connected to one end of a rigid rod rotates at constant speed in a vertical plane about the other end of the rod.

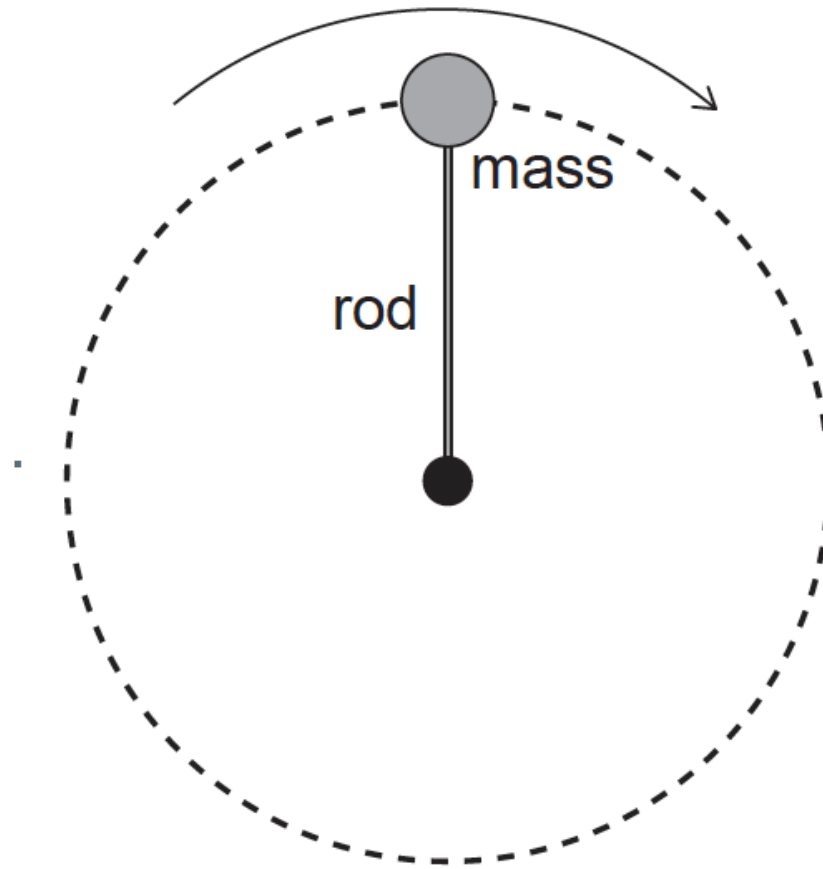

The force exerted by the rod on the mass is

- A. zero everywhere.
- B. constant in magnitude.
- C. always directed towards the centre.
- D. a minimum at the top of the circular path.

Two particles, X and Y, are attached to the surface of a horizontally mounted turntable.

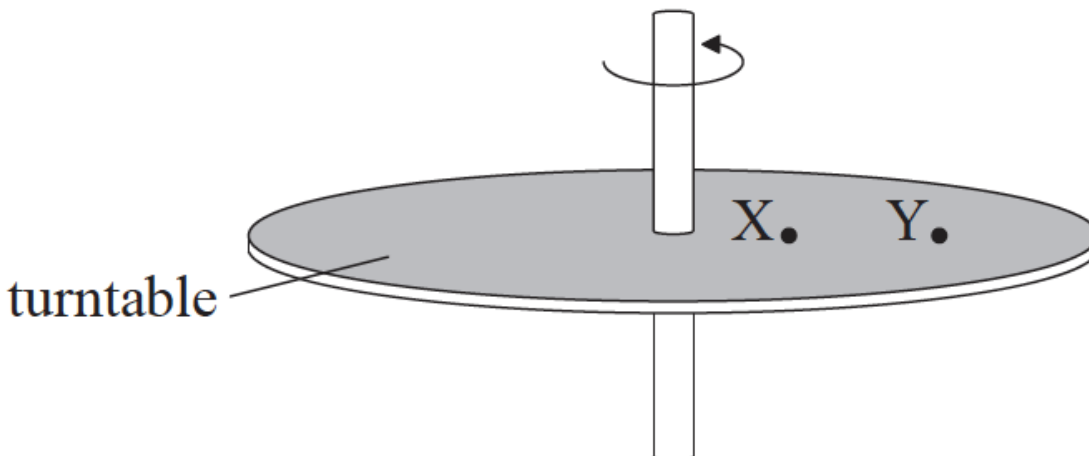

The turntable rotates uniformly about a vertical axis. The magnitude of the linear velocity of X is v and the magnitude of its acceleration is a . Which of the following correctly compares the magnitude of the velocity of Y and the magnitude of the acceleration of Y with v and a respectively?

	Magnitude of velocity of Y	Magnitude of acceleration of Y
A.	equal to v	less than a
B.	greater than v	less than a
C.	equal to v	greater than a
D.	greater than v	greater than a